

BEIJING HUADE HYDRAULIC INDUSTRIAL GROUP CO.,LTD.	Double throttle/check valve, Type Z2FS 6 Series 40 (New Series)			RE:27500/12.2004
	Size 6	up to 31.5MPa	up to 80 L/min	

Features:

- Sandwich plate valve
- Parting pattern to DIN 24340, from A, ISO 4401 and CETOP-RP 121H
- 4 adjustment elements :
 - Screw with locknut and protective cap
 - Lockable rotary knob with scale
 - Spindle with internal hexagon and scale
 - Rotary knob with scale
- For limiting the main or pilot fluid flow of 2 service ports
- For meter-in or meter-out control

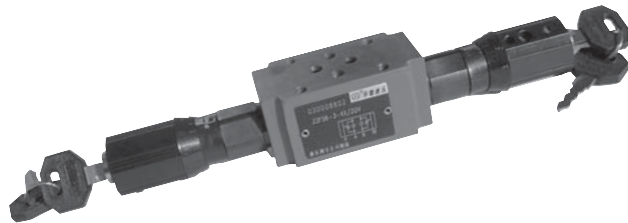

Function , section

Valve type Z2FS 6 ...-40B/... is a double throttle/check valve in sandwich plate design.

They are used to limit the main or pilot flow of one or two service ports. Two symmetrically arranged throttle/check valves limit the flow in one direction and allow free-flow in the opposite direction. For meter-in control fluid passes from port A1 to port A2 via the throttling point (1), which is made up to the valve seat (2) and the throttling spool (3). The throttling spool (3) is axially adjustable via the adjustment screw (4), thus allowing the throttling point (1) to be adjusted. Flow flowing back from the service port A2 moves the valve seat (2) against spring (5) in the direction of the throttling spool (3), causing the valve to act as a check valve and allowing free-flow. Depending upon the way in which the valve is installed, the throttling effect can be arranged as a meter-in or a meter-out control.

Limiting the main fluid flow (style ..2Q..)

In order to change the velocity of an actuator (main fluid flow), the double throttle/check valve is installed between the directional valve and the sub-plate.

Limiting the pilot fluid flow (style ..1Q..)

In pilot operated directional control valves, the double/throttle check valve is installed as a pilot choke adjustment (pilot fluid flow). It is fitted between the main valve and the pilot valve.

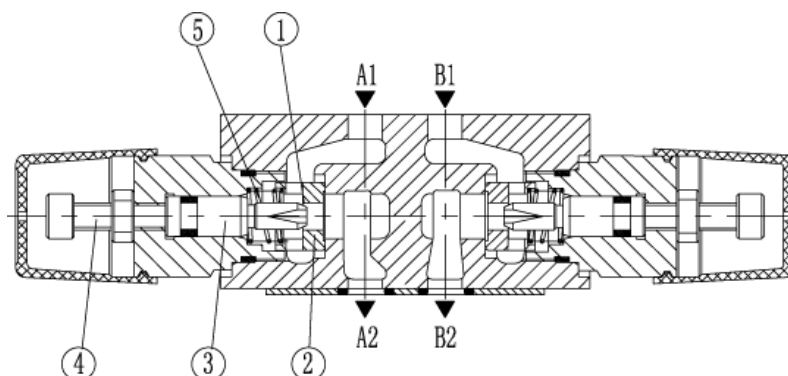

Type Z2FS6-2-40B/...

Ordering details

Z2FS 6 - 40 B / *

Double throttle/check valve

Further details in clear text

Nominal size 6 = 6

No code= Mineral oil
V= Phosphate ester

Throttle/check valve ports A and B = -
Throttle/check valve port A = A
Throttle/check valve port B = B

1Q = With fine control
2Q = Standard version

Adjustment element
Screw with locknut = 2
Lockable rotary knob with scale = 3
Spindle with internal hexagon and scale = 5
Rotary knob with scale = 7

Series 40 to 49 = 40
(40 to 49: unchanged installation and connection dimensions)

Technology of Beijing Huade Hydraulic = B

Note: Type Z2FS 6-...-40B/...has the same adjustment elements on ports A and B

Symbols (① = valve side, ② = sub-plate)

Z2FS6-...-40B/...(meter-in)

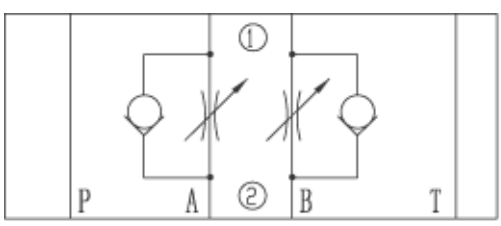

Z2FS6-...-40B/...(meter-out)

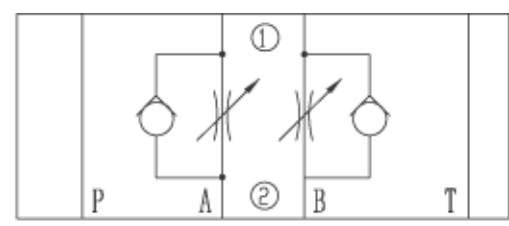

Z2FS 6A-...-40B/...(meter-out)

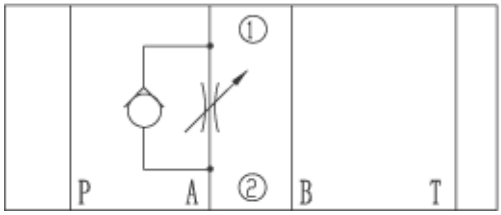

Z2FS 6B-...-40B/...(meter-in)

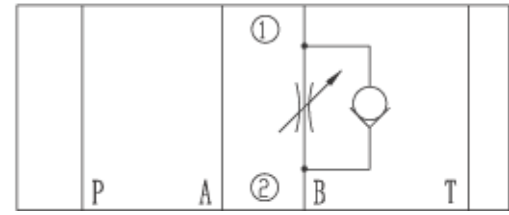

Technical data (for applications outside these parameters, please consult us!)

Pressure fluid	Mineral oil
	Phosphate ester
Pressure fluid temperature range	(°C) - 30 to + 80
Viscosity range	(mm ² /s) 10 to 800
Degree of contamination	Maximum permissible degree of contamination of the hydraulic fluid to NAS 1638 class 9. We therefore recommend a filter with a minimum retention rate of $\beta_{10} \geq 75$.
Maximum working pressure	(MPa) up to 31.5
Maximum flow	(L/min) up to 80
Weight	(Kg) approx. 0.8

Characteristic curves (measured at $v = 41 \text{ mm}^2/\text{s}$ and $t = 50^\circ\text{C}$)

Δp - q_v -characteristic curves - types Z2FS 6 ...-40/2QV
Throttle setting in turns

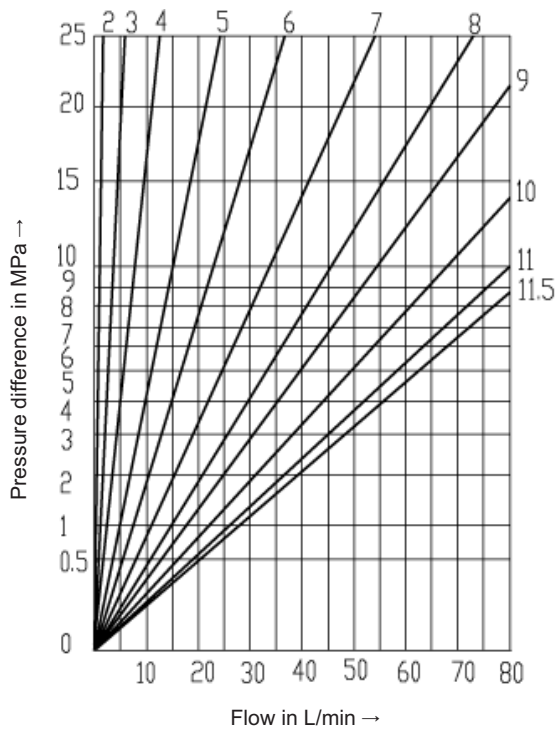

Δp - q_v -characteristic curves - type Z2FS 6 ...-40/1QV
Throttle setting in turns

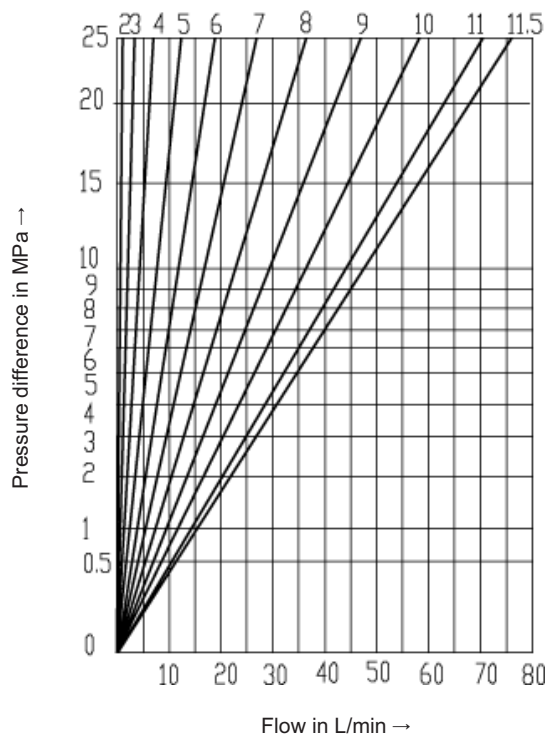

Δp - q_v -characteristic curve across check valve
(throttle closed)

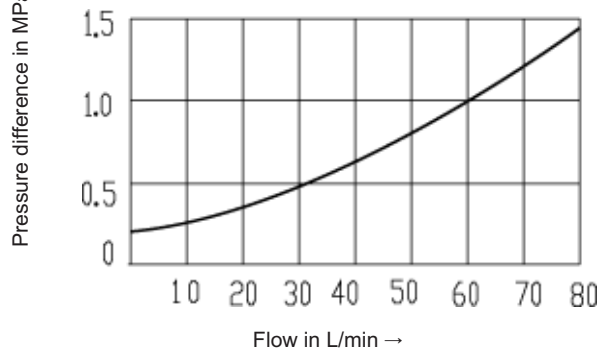

Unit dimensions

(Dimensions in mm)

Type Z2FS 6 A.. - 40/

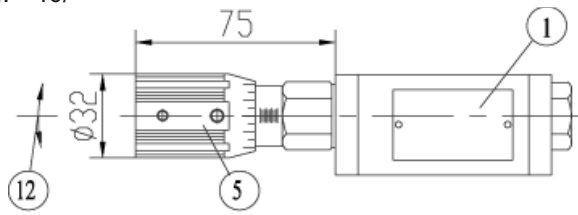

Type Z2FS 6 B.. - 40/

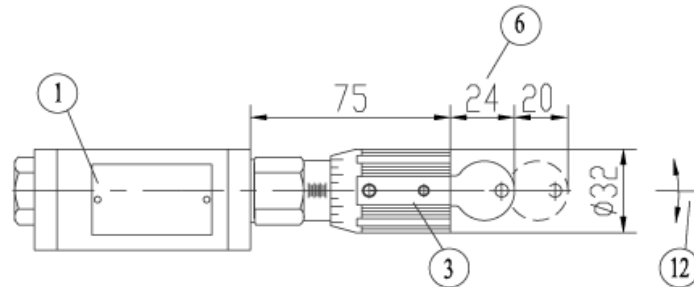

Type Z2FS 6- ... - 40/

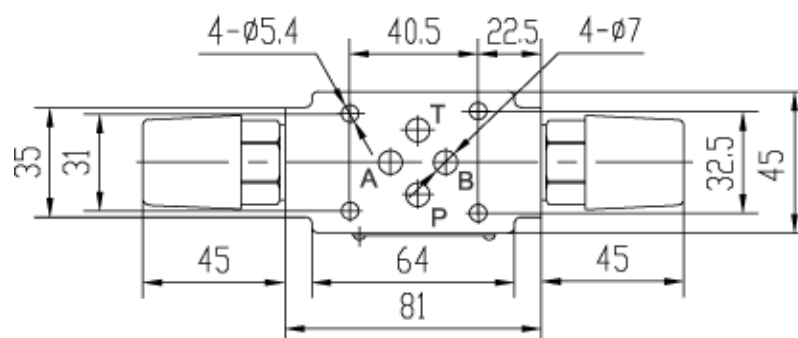
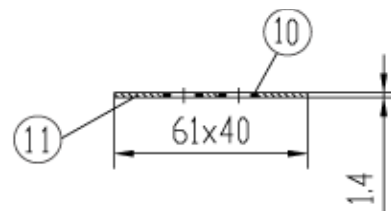
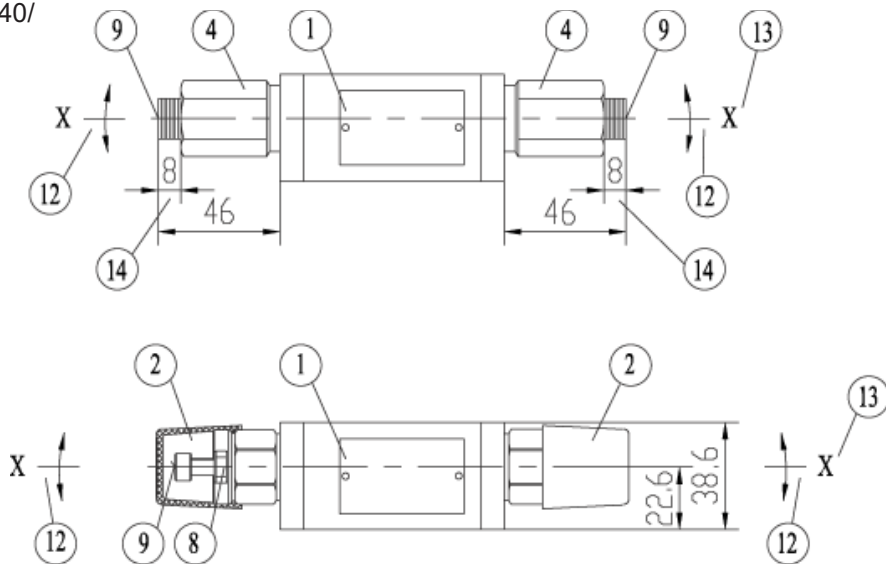

- 1 Name plate
- 2 Adjustment element "2"
- 3 Adjustment element "3"
- 4 Adjustment element "4"
- 5 Adjustment element "7"
- 6 Space required to remove key
- 7 Valve fixing holes
- 8 Locknut 10 A/F
- 9 Adjustment screw/spindle to set flow
cross-section (internal hexagon 5 A/F)
- 10 O-ring 9.25 x 1.78 for ports A, B, P, T
- 11 O-ring plate
- 12 For all adjustment elements:
turn anti-clockwise = increases flow
turn clockwise = decreases flow
- 13 To change from meter-in to meter-out,
rotate the unit about the "X" - "X" axis
- 14 Stroke

Valve fixing screws

M5 --10.9 (GB/T70.1-2000)

Tightening torque $M_A = 8.9 \text{ Nm}$,

Required surface finish of
mating piece

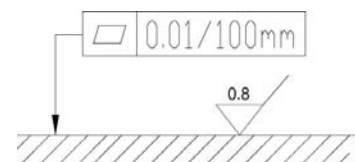

Notice

1. The fluid must be filtered. Minimum filter fineness is 20 μm .
2. The tank must be sealing up and an air filter must be installed on air entrance.
3. Products without subplate when leaving factory, if need them, please ordering specially.
4. Valve fixing screws must be high intensity level (class 10.9). Please select and use them according to the parameter listed in the sample book.
5. Roughness of surface linked with the valve is required to $\frac{0.8}{\nabla}$.
6. Surface finish of mating piece is required to 0.01/100mm.

All rights reserved-Subject to revision

THM Huade Hydraulics (P) Ltd

F-127, Focal Point, Phase VIII

Ludhiana-141010, India

Phone: 0091+161+2672777, Fax: 0091+161+2672778

www.thmhuade.com

info@thmhuade.com & sales@thmhuade.com